

# AIR-CONDITIONING PIPING SYSTEM

---

# RIIFO



Revised on May 05, 2023

# CATALOGUE INDEX

---

03

---

ABOUT RIIFO

06

---

RIIFO APPROVALS

11

---

MULTILAYER PIPING SYSTEM  
FOR AIR CONDITIONING

- 11 Introduction
- 13 Compression Fitting
- 14 Specification
- 17 Installation

05

---

INNOVATION & SCALE

07

---

PROJECT REFERENCE

19

---

AIR CONDITIONING  
PROTECTIVE PIPE SLOT

- 20 System Component
- 22 Installation
- 24 Before & After Installation Of  
Protective Pipe



## ABOUT RIIFO

RIIFO is a leading multinational corporation, providing one-stop piping solutions applied in residential, commercial, agricultural, industrial, and infrastructural sectors. Persistently reinventing since 1996, with over 8,000 employees, 70 branches & subsidiaries, and 300,000 distributors, we have served customers in more than 100 countries and regions.

With an integrated value chain, from R&D to manufacturing and retail distribution, we strive to fulfill our mission of offering ideal piping products and services for all environments.

**8,000**

Employees

**300,000**

Distributors worldwide

**100+**

Serving over 100 countries & regions

**70**

Branches & Subsidiaries



## INNOVATION

Believing that innovation is the key to go beyond the ordinary, RIIFO has founded one world-class labs recognized and certified by CNAS. Over 600 innovation talents have spared no effort to challenge industrial boundaries, achieving 923 patents and 20 technology awards.

And this innovative passion has perfectly presented on high quality products and outstanding services, we strive to offer ideal piping solutions to everyone.

## SCALE

We adopt highly automated production lines with the most rigorous and comprehensive production control, and management system to handle such a powerful production.

### Facility

**9**

global production bases

**5,200+**

production staffs

**200**

hectares area totally

**4,000+**

automated production lines

### Capacity

#### Production Capacity

- Pipe: **3.2 billion** m/yr
- Fitting: **1.3 billion** pcs/yr

#### Storage Capacity

- **1,735,000 m<sup>3</sup>** ≈ 61,950 TEU (20 GP Containers)

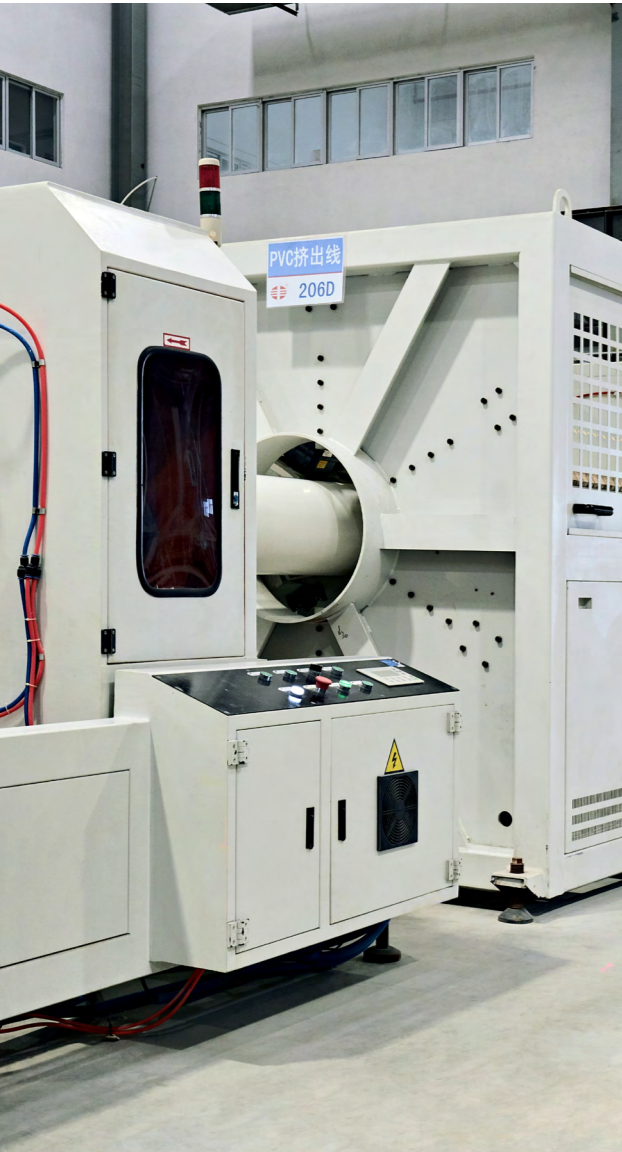

## RIIFO APPROVALS

RIIFO adhere to the concept of quality priority, all RIIFO products are produced under rigorous quality control with excelsior manufacturing. Until now, RIIFO has gained over 50 certificates, such as NSF, DVGW, AENOR, WRAS Watermark, etc. These certificates worldwide underline our technical and quality know-how, and we can provide you with 25 years system warranty backed up by an international insurance company.

### Group Honor



### Certificates

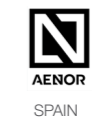

# PROJECT REFERENCE

## Monterey, Mexico

Project: Torre KOI  
Type: Residential  
Year: 2017  
Product: Air-conditioning piping system



## Atlas, Ethiopia

Project: Dodi Extension Tower  
Type: Residential  
Year: 2017  
Product: Air-conditioning piping system



## Sheki, Azerbaijan

Project: Marxal Resort & Spa  
Type: Hotels  
Year: 2016  
Product: Air-conditioning piping system



## Tangerang, Banten, Indonesia

Project: Sky House BSD  
Types: Mixed Use Building  
Years: 2019  
Product: Air conditioning Piping System, air conditioning protective pipe slot





**Tangerang, Banten, Indonesia**

Project: STAN Polytechnic of State Finance  
Types: School  
Years: 2022  
Product: Air-conditioning piping system



**Bogor, Jawa Barat, Indonesia**

Project: Amaris Pakuan Hotel  
Types: Hotel  
Years: 2022  
Product: Air-conditioning piping system



**Merida, Mexico**

Project: Via Montejo  
Type: Residential  
Year: 2017  
Product: Air-conditioning piping system



**Panama City, Panama**

Project: Hospital Punta Pacifica  
Type: Hospital  
Year: 2020  
Product: Air-conditioning piping system



**Jakarta, Indonesia**

Project: Wika Office Tower  
Type: Commercial  
Year: 2016  
Product: Air-conditioning piping system

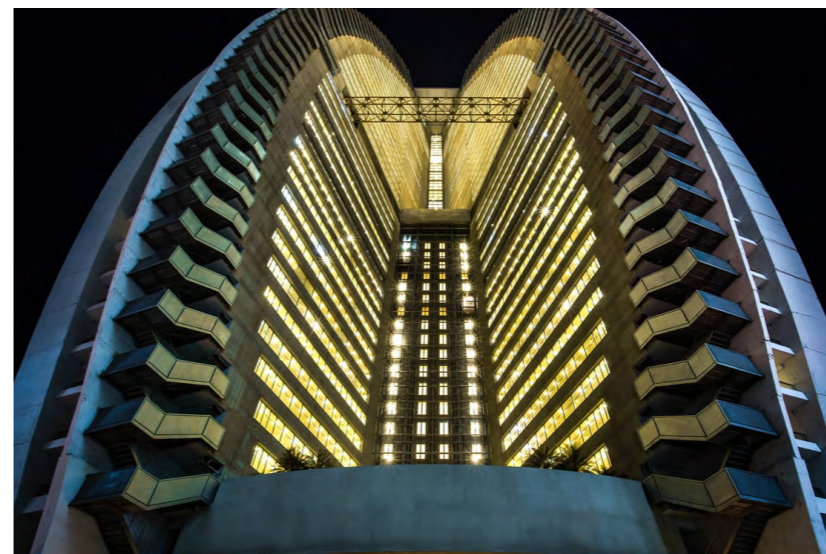



**Panama City, Panama**

Project: JW MARRIOTT PANAMA  
Type: Residential  
Year: 2020  
Product: Air-conditioning piping system

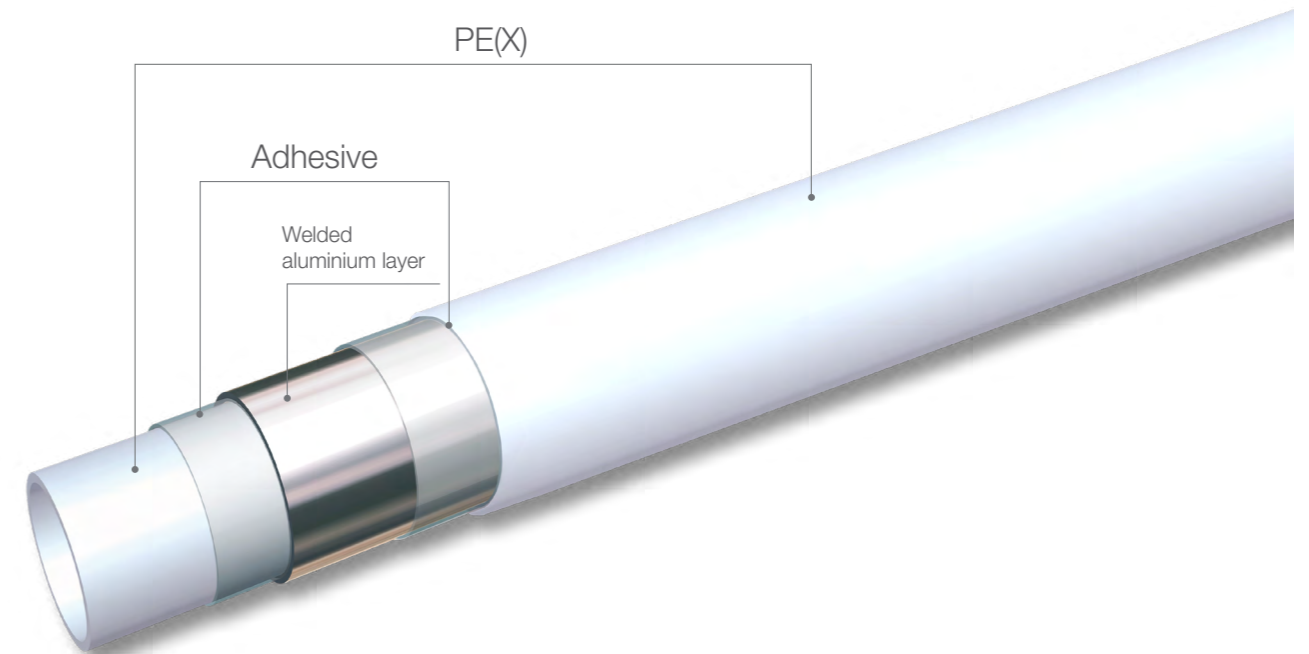
# MULTILAYER PIPING SYSTEM FOR AIR CONDITIONING



-  Easy to install
-  Durable
-  Barrier to the permeation of oxygen and light
-  Multi-layer technology prevents natural corrosion and condensation problems
-  Lower price than copper
-  Light in weight
-  Smooth inner wall ensures low pressure loss
-  Less joints, reducing risk of leakage

## Introduction

Multilayer pipe is a new alternative applied to air conditioning systems. RIIFO multilayer pipe offers air conditioning performance equivalent to copper pipe, but at a low cost. In addition, it reduces installation time with its compression connection system that easily adapts to the air conditioning equipment.

Compared to traditional copper pipe, multilayer pipe is an innovative system that combines the advantages of both plastic and metal pipes, offering ease of fold, tensile strength and extraordinary insulation capacity.

The PEX-AL-PEX multilayer pipe consists of 5 layers, an inner layer of cross-linked polyethylene (PE-X), an adhesive layer, an intermediate layer of aluminum, an adhesive layer and an outer layer of cross-linked polyethylene (PE-X).

### Application

Designed for mini split air conditioning (cooling only).  
 Applicable refrigerant : R-12, R-11 ,R-22, R410A, R404A, R134a , R407A, R407C, R32 etc  
 Operation Temperature: 60°C  
 Operation Pressure:3.8 MPa

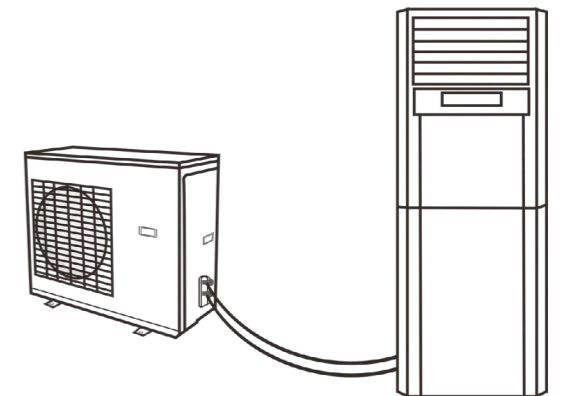

### Standards

- ASTM F1281
- ICC-ES LC1035

### Certificates





## Compression Fitting

### Advantages



Easy installation, no need for welding



Corrosion resistant



Removable and reusable



Safe and reliable



Long service life

Air conditioner		Copper pipe dimension		Valve joint	RIFENG multilayer AC system	
HP	BTU/h	Inch	mm	UNF thread	Pipe	Fittings
1/2, 3/4, & 1	4500~11000	1/4	6.35	7/16'-20UNF	H-0712	F1-S0912*7/16(20UNF) C
		3/8	9.52	5/8'-18UNF	H-0912	F1-S0912*5/8(18UNF) C
1/5 & 2	11000~20000	1/4	6.35	7/16'-20UNF	H-0712	F1-S0912*7/16(20UNF) C
		1/2	12.7	3/4'-16UNF	H-1216	F1-S1216*3/4(16UNF) C
2.5	20000~24000	1/4	6.35	7/16'-20UNF	H-0712	F1-S0912*7/16(20UNF) C
		5/8	15.88	7/8'-14UNF	H-1620	F1-S1620*7/8(14UNF) C
3-5	24000~36000	3/8	9.52	5/8'-18UNF	H-0912	F1-S0912*5/8(18UNF) C
		5/8	15.88	7/8'-14UNF	H-1620	F1-S1620*7/8(14UNF) C
6-8	36000~52000	3/8	9.52	5/8'-18UNF	H-0912	F1-S0912*5/8(18UNF) C
		3/4	19.05	11/16'-14UNF	H-1825 or H-2025	F1-S1825*1 1/16(14UNF) C or F1-S2025*1 1/16 (14UNF) C

## Specification

PEX-AL-PEX (H Serie)



Spec.	Packing Spec. (m)	Color(out/in)
H-0712	50/100	Golden/Transparent or White/Transparent
H-0912	50/100	Golden/Transparent or White/Transparent
H-1216	50/100	Golden/Transparent or White/Transparent
H-1620	50/100	Golden/Transparent or White/Transparent
H-1825	50/100	Golden/Transparent or White/Transparent
H-2025	50/100	Golden/Transparent or White/Transparent
H-2632	50/100	Golden/Transparent or White/Transparent

Insulated Air Conditioning Pair Coil



Pair coil	Pipe spec.	Coil thickness(mm)	Packing Spec. (m)
1/4"+3/8"	H-0712+0912	10	25/30
1/4"+1/2"	H-0712+1216	10	25/30
1/4"+5/8"	H-0712+1620	10	25/30
3/8"+5/8"	H-0912+1620	10	25/30
1/4"+3/8"	H-0712+0912	8	25/30
1/4"+1/2"	H-0712+1216	8	25/30
1/4"+5/8"	H-0712+1620	8	25/30
3/8"+5/8"	H-0912+1620	8	25/30
3/8"+3/4"	H-0912+1825/2025	8	25/30



## Female straight coupling



Spec.	Pcs/Box	Pcs/Ctn.
F1-S0712x5/8(18UNF) C	42	336
F1-S0712x7/16(20UNF) C	56	448
F1-S0912*7/16(20UNF) C	56	448
F1-S0912*5/8(18UNF) C	42	336
F1-S1216*3/4(16UNF) C	30	240
F1-S1620x7/8(14UNF) C	25	200
F1-S1825x1 1/16(14UNF) C		128
F1-S2025x1 1/16(14UNF) C	20	160

## Straight Coupling



Spec.	Pcs/Box	Pcs/Ctn.
F1-S0912x0912 C	42	336
F1-S1216x1216 C	24	192
F1-S1620x1620 C	20	160
F1-S1825x1825 C		135
F1-S2025x2025 C	14	112
F1-S2632x2632 C		96

## Compression to Copper Pipe Adapter



Spec.	Pcs/Box	Pcs/Ctn.
F1-S0912x1/4CuF(B280) C	50	400
F1-S0912x3/8CuF(B280) C	40	320
F1-S1216x1/2CuF(B280) C	50	400
F1-S1620x5/8CuF(B280) C	20	160
F1-S2025x3/4CuF(B280) C	24	192

\*For copper pipe in line with ASTM B280

## Pipe cutter



Spec.	Pcs/Box	Pcs/Ctn.
GJ IV		40

## Reamer



Spec.	Pcs/Box	Pcs/Ctn.
Reamer 0912	10	50

## Plastic reamer



Spec.	Pcs/Box	Pcs/Ctn.
ZYD2-0912-1216-1620	10	200
ZYD2-1216-1620-2025	10	180
ZYD2-1620-2025-2632	10	100
ZYD2-0912-1216-1825	10	200

## Internal bending spring



Spec.	Pcs/Box	Pcs/Ctn.
WH-1216	25	150
WH-1620	15	90
WH-1825	9	54
WH-2025	9	54
WH-2032	4	24

## External bending spring



Spec.	Pcs/Box	Pcs/Ctn.
WH-1216 II	6	36
WH-1620 II	4	24
WH-2025 II	2	12
WH-2632 II	1	6

# Installation

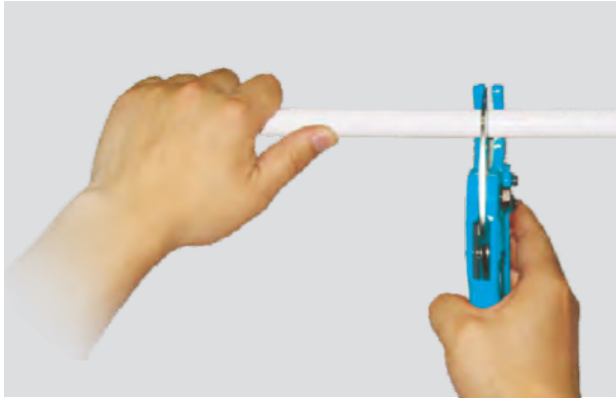

Step1:  
Cut the pipe vertically and precisely with a pipe cutter.



Step2:  
Round and bevel the ends with the RIFFO reamer



Step 3:  
Choose the right size of the fitting according to the pipe;  
place the nut and then the compression ring onto the pipe.  
Please note the threaded opening must face the end of the pipe.

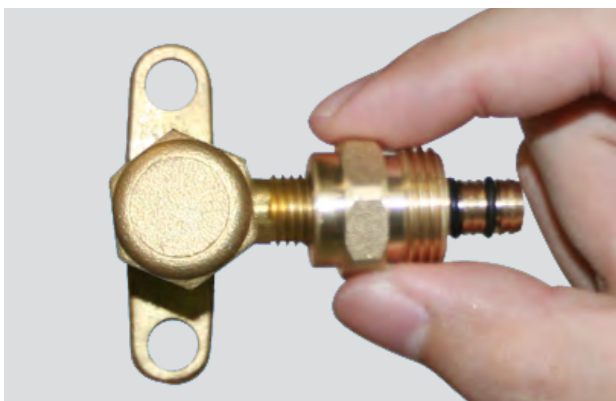

Step 4:  
Install the fitting on the air conditioning valves.

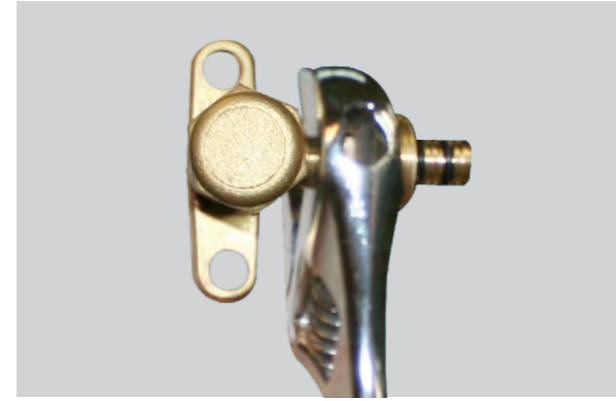

Step 5  
Tighten the fitting with a wrench

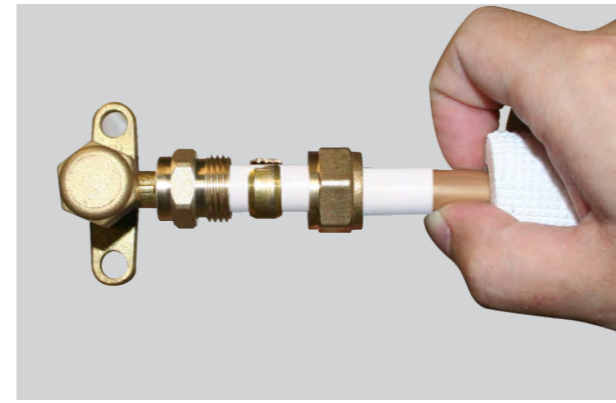

Step 6:  
Push the inserts into the pipe up to the shoulder, take care not to damage the O-ring.

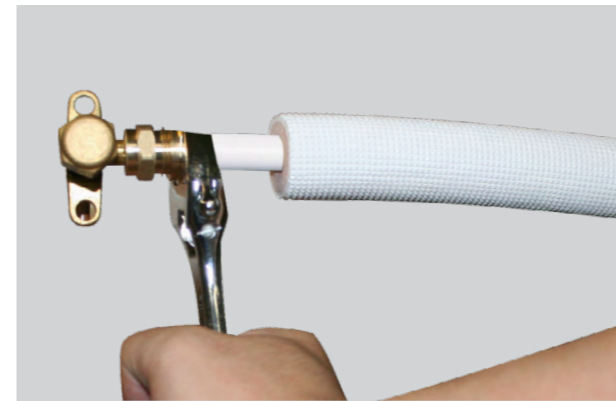

Step 7:  
Tighten the nut with a wrench

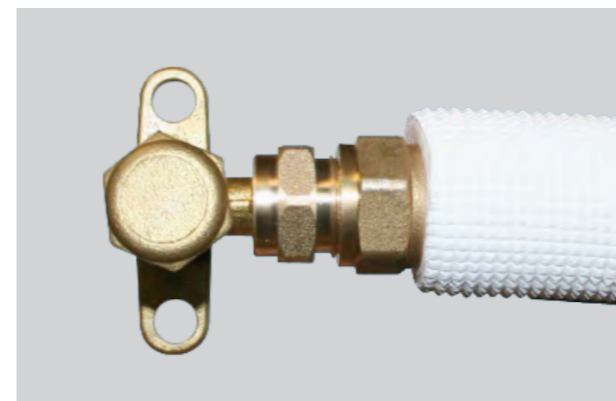

Step 8:  
Install insulation sleeve

# AIR CONDITIONING PROTECTIVE PIPE SLOT

The RIIFO protective pipe system for air conditioning is designed with high-quality PVC raw materials that possess exceptional properties. These pipes are equipped with V0-class flame retardance, enabling them to self-extinguish in case of a fire outbreak, and can resist up to 2000V voltage fault, ensuring reliability and safety. Furthermore, they are resistant to acid and alkali as well as ultraviolet rays, providing effective protection to air conditioning pipes and extending their lifespan. The seamless modular splicing design facilitates easy installation, while the sealed connection prevents air convection, noise, and pests damage. Additionally, the white appearance of the pipes provides a clean and neat finish after installation.

In addition, our protective pipe slot offers significant cost and energy savings benefits. Damaged air conditioning pipes or insulation can lead to higher maintenance costs or even equipment replacement, which can be avoided with our protective pipe slot. By protecting the pipes' insulation, our product also helps to increase the efficiency of the system and reduce energy consumption, resulting in energy savings.

## Advantages

- No pungent smell
- Acid and alkali resistance
- Self-extinguishing from fire
- Resistant to ultraviolet
- Long service life
- Reduce maintenance costs
- Energy Saving
- Sealed connections isolate air convection, and eliminate noise and pests



Performance parameter			
Characteristic	Testing method	Unit	Value/range
Vicat softening point (method 860)	ISO 306	°C	80
Thermal conductivity (20°C)	ISO 8302	W/mk	~ 0.17
Material grade	DIN EN 13501-1		E
Linear expansion coefficient	ISO 11359	K-1	0.8*10 <sup>-4</sup>
Specific heat capacity	ISO 11357	KJ/kgK	~ 1.05
Material performance description, measured at 23°C			
Characteristic	Testing method	Unit	Value/range
Density	ISO 1183	g/cm <sup>3</sup>	1.80±0.02
Tensile strength	ISO 527	N/mm <sup>2</sup>	≥ 15
Elongation at break	ISO 527	%	≥ 15
Bending strength	ISO 527	N/mm <sup>2</sup>	≥ 5
Impact strength 0°C	ISO 179 <sup>-1</sup> 1eU	KJ/m <sup>2</sup>	Not broken
Impact strength 20°C	ISO 179 <sup>-1</sup> 1eU	KJ/m <sup>2</sup>	Not broken
Notched impact strength	ISO 179 <sup>-1</sup> 1eA	KJ/m <sup>2</sup>	≥ 1
Elastic Modulus	ISO 178	N/mm <sup>2</sup>	> 200
Shore D hardness	DIN 53606		81±3

# System Component



**Protective pipe**  
Used for effectively fixing and protecting air conditioning pipe



**Straight coupling**  
Used for extension and connection of protection pipeline in order to meet the installation requirements of any length.



**Elbow 90°**  
Apply to the pipe connection of vertical wall corner (available for both inner and outer corners) It can be rotated horizontally and vertically 90° to change the pipeline direction.



**Flat Elbow 90°**  
Applicable for connecting and redirecting pipes on flat walls. 90 degrees Horizontal and vertical rotation can change the direction of the pipe, but does not change the installation plane of the pipe.

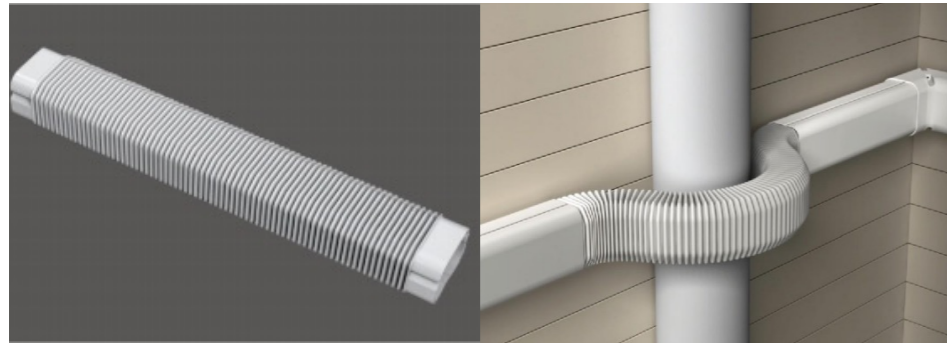

### Flexible coupling

Apply to the air conditioning protection pipe slot to cross obstacles and get connecting in multiangle, and any radian. Scalable, suitable for any scene and convenient for construction.



### Reducer End Cap

Applicable for end connection between air conditioner and protective pipe.



### Wall Entry Cap 90°

Installation and connection of 90 degrees angle between air conditioning holes and outer wall. Seamless modular splicing makes fast installation, and isolates noise caused by air convection, and pests.



### Wall Entry Cap

Installation and connection of air conditioning holes inside and outside the wall. Seamless modular splicing makes fast installation, and isolates noise caused by air convection, and pests.

## Installation

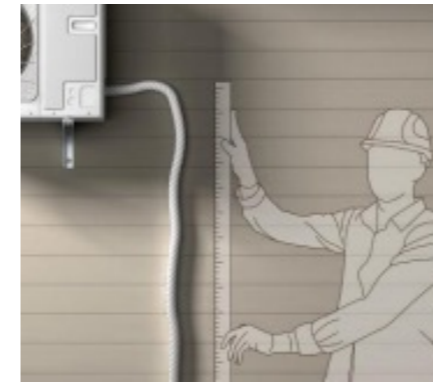

Use a measuring tool to measure the length of the air conditioning pipe.



Determine the distance and position of connection points, and mark the installation position of pipes and fittings.

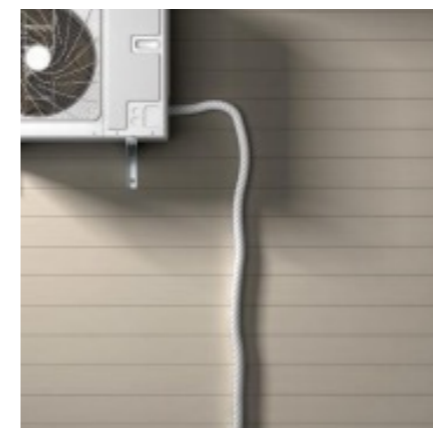

Check whether the pipeline is in line with the previous marked position. If it is in line, start the installation; and if not, re-determined the installation position.

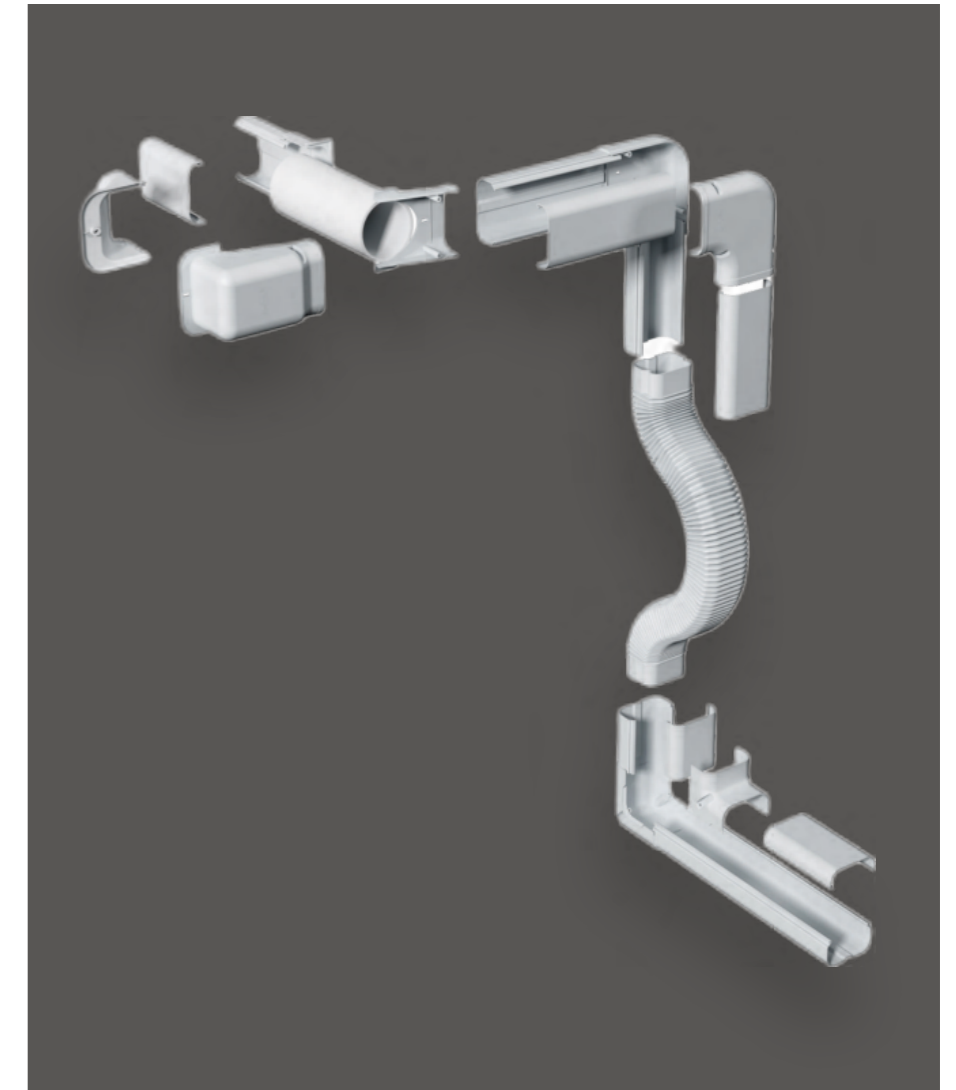

Install and place the air conditioning pipe into the protective pipe system and fix the air conditioning pipe



After installation, use the cover to protect the pipe



Fix the protective pipe. Check whether the buried electric wire is in the same position to avoid damage during drilling.

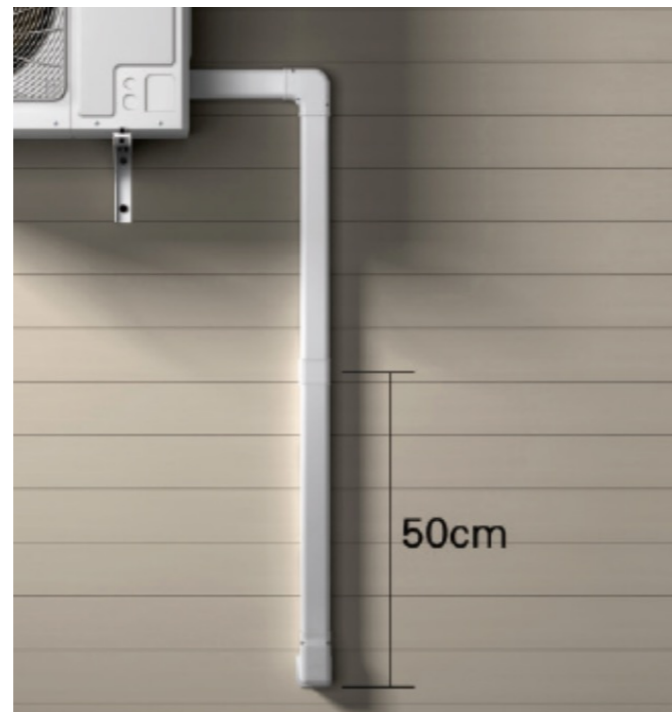

The distance between the starting point and the end point should not exceed 50cm, so as to prevent the protective pipe from warping and deformation, affecting the overall appearance.



When the installation of the protective pipe encounters obstacles or the situation where pipe cannot be installed properly, flexible coupling shall be used for connection.



During the installation of air conditioner, carefully bend the pipe so as to avoid fracture, which may lead to the difficulty of sealing the cover plate.

## BEFORE & AFTER INSTALLATION OF PROTECTIVE PIPE

BEFORE



AFTER



BEFORE



AFTER

